

Antennas AD-2/WB represent the family of transceiving self-supporting HF wideband monopoles. The antennas are composed of three sections, connected together by screw-joints, protected against unscrewing with cross screw protecting unit. The first part of the antenna is support with antenna matching unit underneath. Inside the base is the matching circuitry and (optional) GPS antenna. The N-type connector is mounted on the side of the antenna base. The support flange is convenient for mounting directly on deck.

The antenna sections are made of epoxy-glass composite material and the screw joints are made of stainless steel. The antennas are very lightweight but on the other side they are highly resistant against all weather conditions. The flange on the support type is made of special polyamide and aluminum with excellent mechanical characteristics. Antennas AD-2/WB are intended primarily for use on all kind of ships, oil rigs etc. They could be also used on ground objects for stationary use. In that case a special wire ground-plane must be ordered.

ELECTRICAL SPECIFICATIONS :	
Frequency range	1 - 30 MHz
Impedance	50 ohms
VSWR	< 2,5
Gain	-30 ... +3 dBi
Polarization	vert.
Radiation pattern	Omnidirectional
Maximum power	200 W CW
Connector	N female
MECHANICAL SPECIFICATIONS:	
Design	End fed whip
Height	7 m
Weight	11 kg (S3 8 kg, S2 2 kg, S1 1 kg)
Temperature range - in use	-40 ... +70 °C
Temperature range - in stock	-50 ... +85 °C
Wind rating	45 m/s (160 km/h)
Color	MIL Green
ENVIRONMENTAL SPECIFICATIONS (per MIL-STD-810G):	
High Operating Temperature	+70 deg C Method 501.5 Proc. II
Low Operating Temperature	-40 deg C Method 502.5 Proc. II
High Temperature Storage	+85 deg C Method 501.5 Proc. I
Low Temperature Storage	-50 deg C Method 502.5 Proc. I
Humidity	Method 507.5 Proc. II
Salt Fog	Method 509.5
Vibration	Method 514.6 Proc. I
Immersion	Method 512.5 Proc. I
Rain	Method 506.4 Proc. II
Sand and Dust	Method 510.5 Proc. I
Solar Radiation	Method 505.5 Proc I
Fungus	Method 508.5



7000

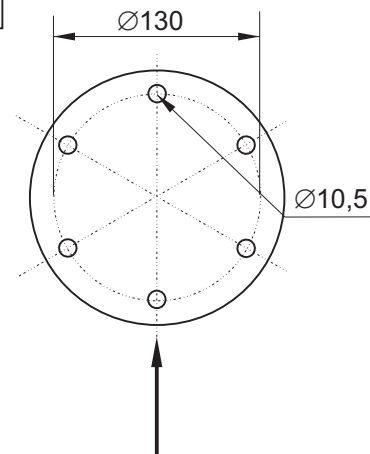
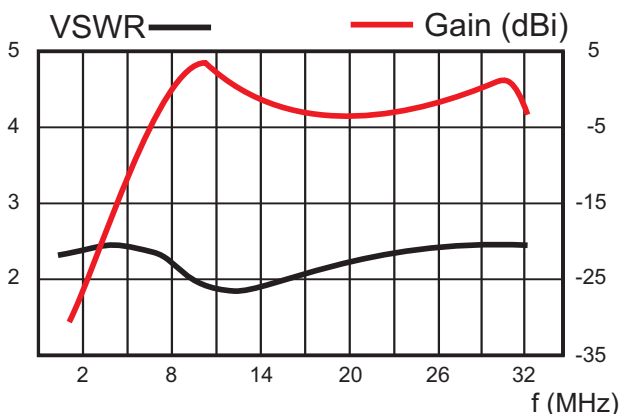

VERTICAL RADIATION PATTERN OVER PERFECT ELECTRICAL CONDUCTOR

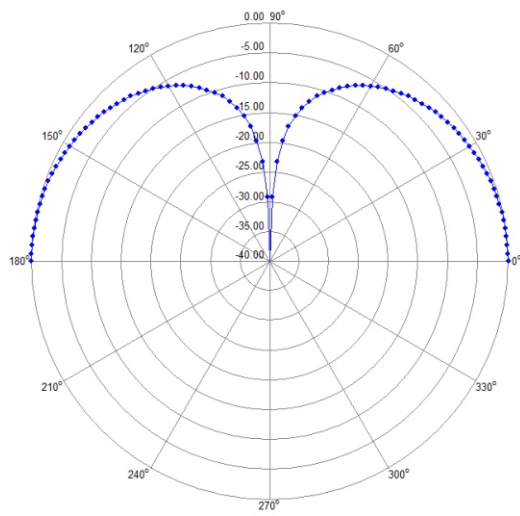

1 MHz

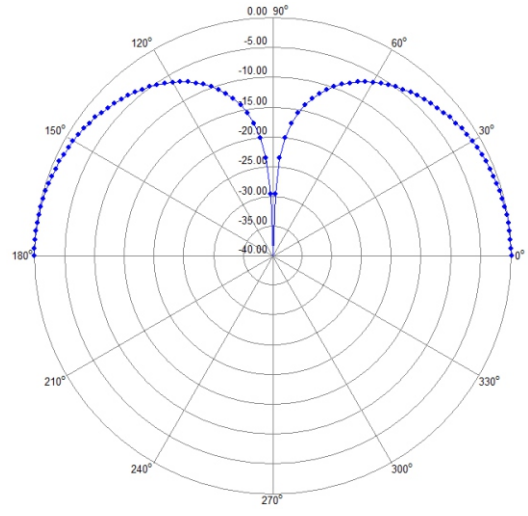

6 MHz

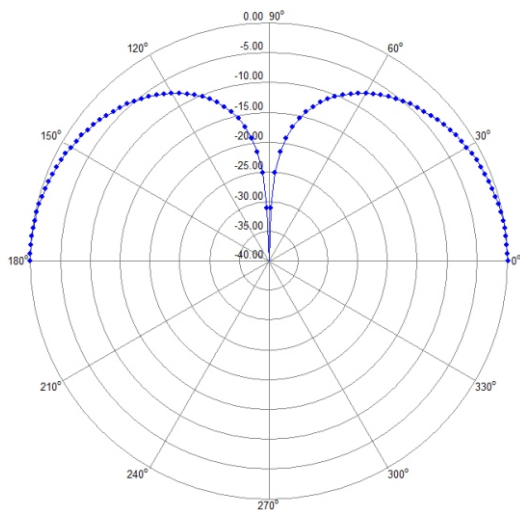

12 MHz

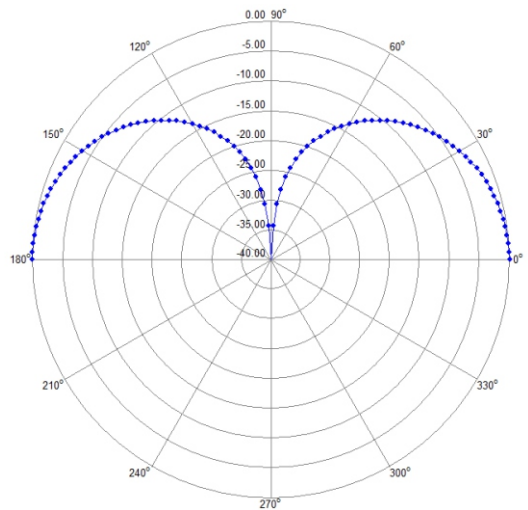

18 MHz

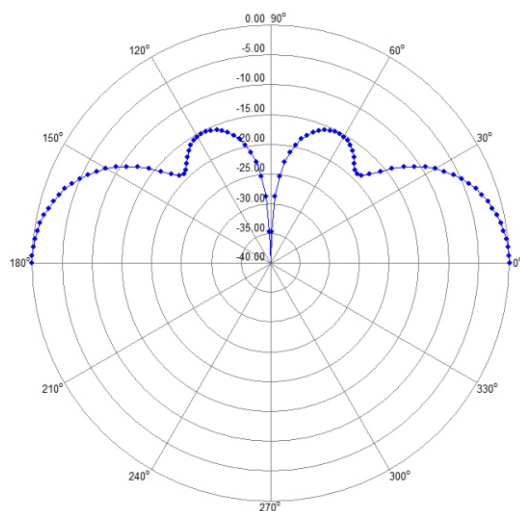

24 MHz

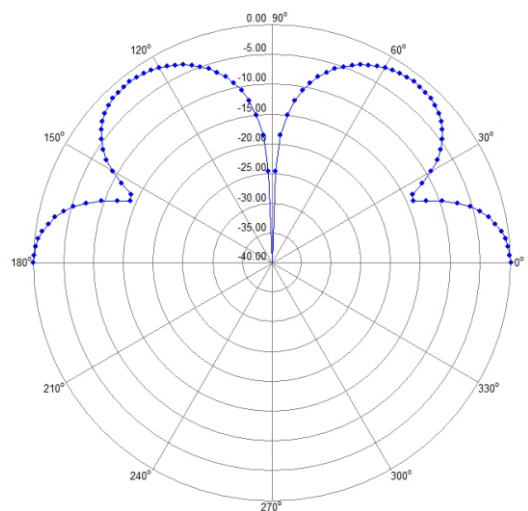

30 MHz