

The antenna AD-18/G-50300 is a wideband UHF antenna for frequency range from 500 to 3000 MHz, mainly intended for use in heavy duty mobile applications. The antenna is composed of two main parts: the antenna base and the radiating element. The antenna base is made of aluminum and durable plastic materials. Inside the base is mounted (optional) GPS antenna. Stainless steel spring absorbs shocks and vibrations. Radiating elements are made of aluminum alloy and are enclosed inside epoxy composite tube enable outstanding strength and roughness even in hardest conditions of use. The antenna base has four mounting holes equally spaced on a 4.5" (114.3 mm) circle which complies with NATO standard. Different base plate dimensions are available on request. The antenna radiator is painted with black PU two-component UV resistant paint.

ELECTRICAL SPECS - UHF	
Frequency range	500 - 3000 MHz
Impedance	50 ohm
VSWR	< 2.5
Gain	1 - 2.5 dBi
Polarization	Vertical
Maximum power	500 W (450 MHz) 200 W (3000 MHz) CW
Connector	N female
ELECTRICAL SPECS - GPS	
Frequency range	L1 1575.42 +/- 10 MHz
Impedance	50 ohm
VSWR	<2
LNA Gain / Voltage / Current	18 dB (+/- 2 dB) / 5 V / 19 mA 16 dB (+/- 2 dB) / 3.5 V / 13 mA 10 dB (+/- 2 dB) / 2 V / 7 mA
Polarization	RHC
Noise fig.	<1.5 dB
Connector	SMA female
MECHANICAL SPECS	
Design	Dipole (Center-Fed) Antenna
Height	470 mm
Weight	3.3 kg
Max Radiator Diameter	89 mm
Temperature range - in use	-50 ... +55 °C
Temperature range - in stock	-55 ... +75 °C
Wind rating	45 m/s (160 km/h)
Color	Black



VERSIONS:

AD-18/G-50300-N: UHF Antenna

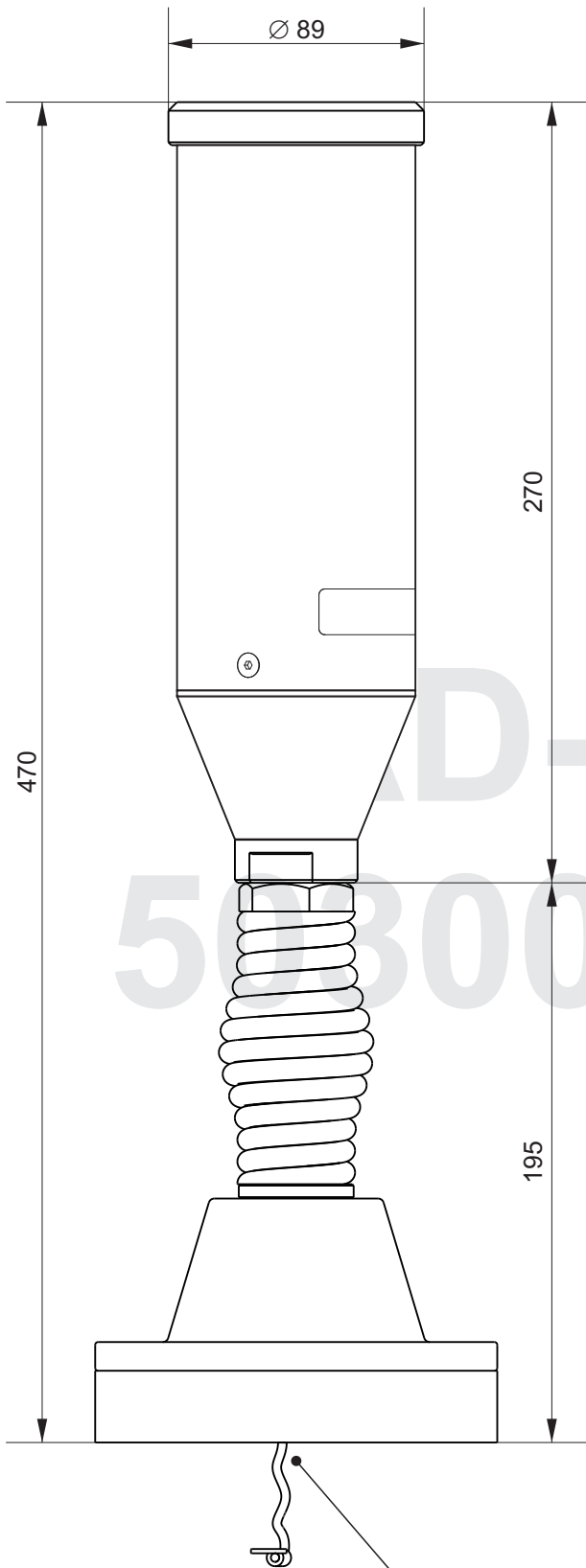
AD-18/G-50300-G-N: combined UHF and GPS Antenna (L1)

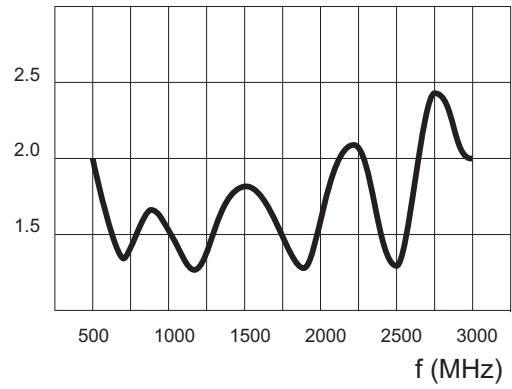

VSWR



Gain (dBi)

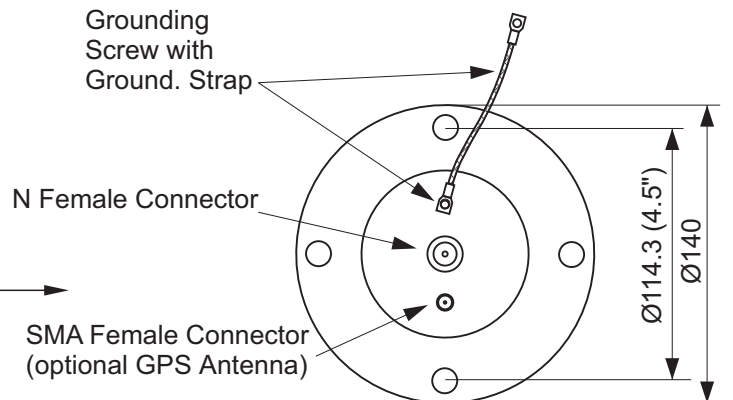
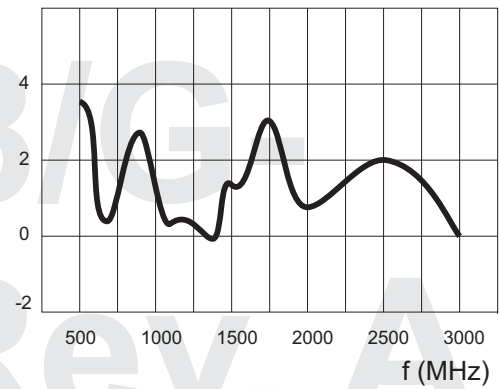

ANTENNA BASE -
BOTTOM VIEW